

MITEL

# 5560 IPT

User Guide – Release 1.0



## **NOTICE**

The information contained in this document is believed to be accurate in all respects but is not warranted by Mitel Networks™ Corporation (MITEL®). The information is subject to change without notice and should not be construed in any way as a commitment by Mitel or any of its affiliates or subsidiaries. Mitel and its affiliates and subsidiaries assume no responsibility for any errors or omissions in this document. Revisions of this document or new editions of it may be issued to incorporate such changes.

No part of this document can be reproduced or transmitted in any form or by any means - electronic or mechanical - for any purpose without written permission from Mitel Networks Corporation.

## **TRADEMARKS**

Mitel is a trademark of Mitel Networks Corporation.

Windows and Microsoft are trademarks of Microsoft Corporation.

Other product names mentioned in this document may be trademarks of their respective companies and are hereby acknowledged.

## **Mitel 5560 IPT - User Guide**

April 2007

®,™ Trademark of Mitel Networks Corporation  
© Copyright 2007, Mitel Networks Corporation  
All rights reserved

## Table of Contents

<b>ABOUT YOUR 5560 IPT .....</b>	<b>1</b>
Elements of Your 5560 IPT.....	1
Ring/Message indicators.....	3
<b>TIPS FOR YOUR COMFORT AND SAFETY .....</b>	<b>4</b>
Don't cradle the handset! .....	4
Protect your hearing.....	4
Adjust the viewing angle.....	4
<b>5560 IPT AUDIO MODES.....</b>	<b>4</b>
Switching Audio Modes.....	5
Switching between Audio Paths in Dual Audio Mode .....	6
Tips for Using this Guide .....	6
<b>USING YOUR DEFAULT WINDOWS AND KEYS.....</b>	<b>7</b>
Getting Started with 5560 IPT.....	7
For Users on Resilient 3300 ICP Systems .....	8
<b>USING YOUR 5560 IPT APPLICATIONS.....</b>	<b>9</b>
Using the Settings Application .....	9
Getting Help.....	10
<b>CUSTOMIZING YOUR 5560 IPT.....</b>	<b>11</b>
Specify User Information .....	11
Using the Onscreen Keyboard.....	11
Specify Display Brightness and Contrast.....	12
Specify Audio Feedback Options.....	12
Specify Text Size .....	13
Specify Call Notification Behavior .....	13
Adjust Ringer .....	14
Enable a Screen Saver.....	14
<b>PROGRAMMING FEATURES ON YOUR KEYS.....</b>	<b>15</b>
Tips for Programming Features .....	15
Program Feature Keys Using the Settings Application.....	16
To program Speed Call: .....	17
Edit Key Labels.....	17

Clear Programming from a Key .....	17
<b>USING THE PEOPLE APPLICATION.....</b>	<b>18</b>
Setting Up Your Contact List .....	18
Editing information in your contact list .....	18
<b>USING THE CALL INFO APPLICATION .....</b>	<b>18</b>
<b>USING THE CALL FORWARDING APPLICATION.....</b>	<b>19</b>
Program Call Forward Profiles .....	19
Activate Call Forwarding Profile .....	20
Cancel Call Forwarding Profile.....	20
<b>MAKING AND ANSWERING CALLS .....</b>	<b>21</b>
Dial from a Private Line Key .....	21
Dial from a Speed Call Key.....	21
Dial from the People Application.....	21
Dial from the Keypad .....	21
Phone Book .....	22
Answer a call .....	22
To answer using speaker/microphone: .....	22
End a call .....	23
Switch between two active calls (Dual Audio Mode).....	23
Redial.....	23
Redial - Saved Number .....	23
Handsfree Operation .....	23
Auto-Answer .....	24
<b>CALL HANDLING .....</b>	<b>25</b>
Hold .....	25
Transfer .....	25
Conference .....	25
Conference Split .....	26
Add Held .....	26
Swap.....	26
<b>USING OTHER FEATURES.....</b>	<b>27</b>
Account Codes .....	27
Attendant Call Hold - Remote Retrieve.....	27

---

Callback .....	27
Call History .....	28
Call Park .....	28
Call Pickup.....	29
Campon .....	29
Direct Paging .....	30
Do Not Disturb .....	30
Emergency Calls.....	30
Group Listen .....	31
Group Paging / Meet Me Answer.....	31
Headset Operation.....	32
Hot Desking .....	32
Hot Desk Remote Logout .....	33
Hot Desk - PIN Change .....	33
Message .....	33
Message Waiting Indicator .....	33
Messaging - Advisory .....	34
Message - Callback .....	34
Messaging - Cancel Callback .....	34
Messaging - Cancel All Callbacks .....	34
Music .....	35
Night Answer .....	35
Override (Intrude) .....	35
Paging.....	35
Reminder .....	35
Ringer Adjust .....	36
Speak@Ease.....	36
Speed Call .....	37
Tag Call .....	37
Trunk Flash.....	37



## ABOUT YOUR 5560 IPT

The Mitel 5560 IPT® is a full-feature, dual port, enterprise-class financial trading device that provides voice communication over an IP network. Engineered specifically for the high call volumes of trading environments, the 5560 IPT features:

- two large graphics displays (160 x 320) with self-labeling keys
- optional simultaneous access to two active calls
- separate connections and one-touch switching for dual handsets and/or headsets

The 5560 IPT offers 94 programmable multi-function keys for one-touch feature access. It also provides ten fixed feature keys for convenient access to features such as Conferencing, push-to-talk microphone, customizable user settings, and navigational keys to access various screens and application layers.

The 5560 IPT supports Mitel Call Control (MiNet) protocol. It also supports Hot Desking, Clustered Hot Desking, and Resiliency, and can be used as a Teleworker phone.

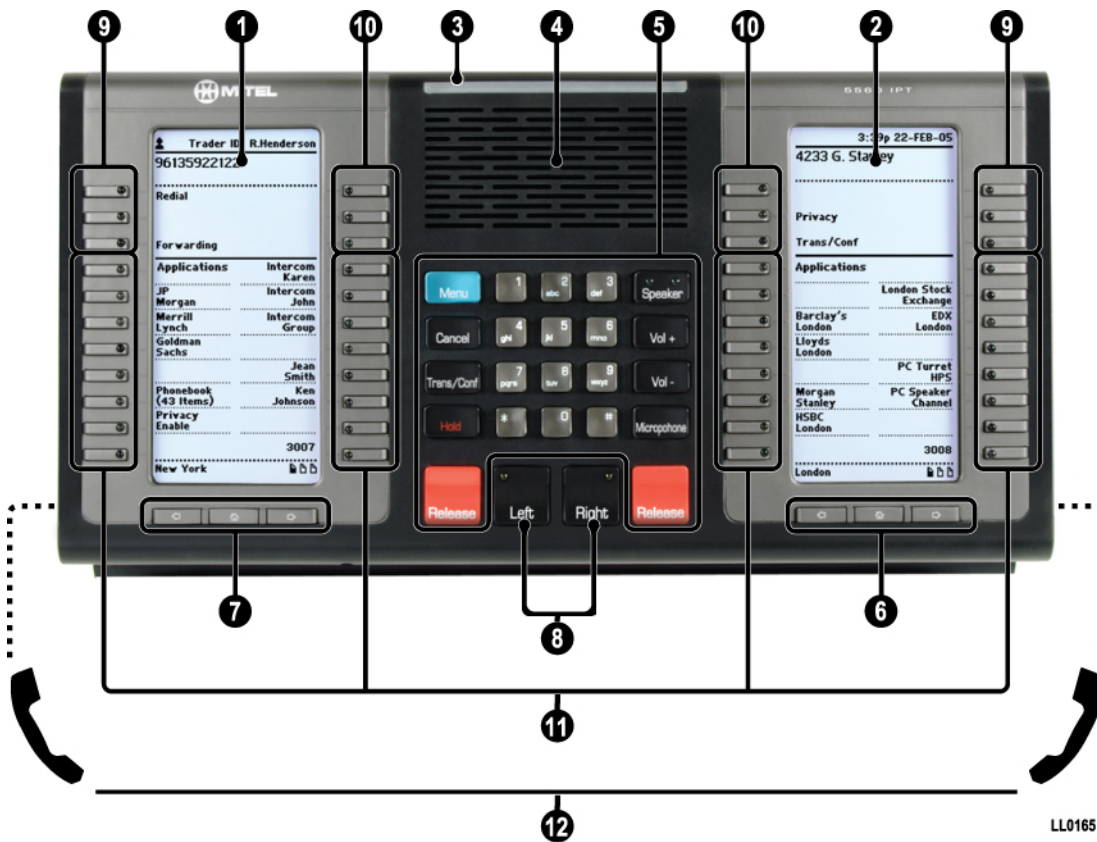

Figure 1. The 5560 IPT

### Elements of Your 5560 IPT

Feature	Function
1) Left (Master) Side and 2) Right (Slave) Side	Provides two large, high-resolution viewing areas that assist you in selecting and using 5560 IPT features.
3) Ring/Message Indicator	Flashes to signal an incoming call or to indicate a message waiting in

## Elements of Your 5560 IPT

Feature	Function
	your voice mailbox.
4) Handsfree Speaker	Provides audio for Handsfree calls, paging, and background music.
5) Fixed Function Keys and Common Keypad	<p>Common and fixed-function keys provide the following 5560 IPT functions, and audio control capability for both Left and Right displays:</p> <p><b>Speaker:</b> enables and disables <b>Handsfree</b> mode. See <i>Handsfree Operation</i> on page 23 for more information.</p> <p><b>Menu:</b> provides access to menus for your 5560 IPT's additional features.</p> <p><b>Trans/Conf:</b> initiates a call transfer or establishes a three-party conference call.</p> <p><b>Hold:</b> places the current call for the corresponding handset (left or right) on hold.</p> <p><b>Release</b> (two keys, one for each handset): when pressed during a call, ends the call (for the corresponding left or right handset).</p> <p><b>Microphone</b> either toggles the microphone ON and OFF (when pressed and immediately released), or allows push-to-talk microphone use (when pressed and held). Illuminated LED indicates microphone ON state for the selected call.</p> <p><b>Vol +</b> and <b>Vol -</b> provide volume control for the ringer, handset, and handsfree speakers.</p> <p><b>Keypad:</b> use to dial or enter numbers on the active display.</p> <p><b>Cancel:</b> use to end a call and return to the dial tone.</p>
6) Navigation Page Keys for the Right Side and	Use to display additional pages of information. The 5560 IPT has three page navigation keys for each display: Back, Next, and Home. The Home key returns the display to the first page of applications with multiple pages.
7) Navigation Page Keys for the Left Side	
8) Left and Right Keys	<b>Left</b> and <b>Right:</b> Maintain control over the common keys, which include <b>Menu</b> , <b>Speaker</b> , <b>Trans/Conf</b> , <b>Vol +</b> , <b>Vol -</b> , and the keypad. Also switch between the left and right handsets or headsets.
9) Softkeys	On the Left and Right sides, the top three keys closest to the outside edges of the terminal are softkeys. Key labels change depending on context.
10) Float Keys	On the Left and Right sides, the top three keys closest to the center of the terminal are Float keys. Up to three concurrent incoming calls appear on Float keys with associated labels.

- 11) Programmable Feature Keys      Total of 94 self-labeling programmable keys (15 keys on the home page and 16 keys on pages 2 and 3 for each side).  
These keys can be programmed as speed call keys, feature keys, applications, or line appearance keys, according to your communication needs. The bottom right feature key on each home page is always the Prime Line key.
- 12) Handsets      You can connect one or two handsets to the 5560 IPT. If desired, you can replace one or both handsets with a telephony headset. For more information about audio device connectivity, refer to the *5560 IPT Installation Guide*.

### **Ring/Message indicators**

<b>When indicator is...</b>	<b>it means that...</b>
Flashing rapidly	Your 5560 IPT is ringing
Flashing slowly	A message or callback message is waiting at your 5560 IPT
Off	Your 5560 IPT is idle, or you are on a call

## TIPS FOR YOUR COMFORT AND SAFETY

### Don't cradle the handset!

Prolonged use of the handset can lead to neck, shoulder, or back discomfort, especially if you cradle the handset between your ear and shoulder. If you use your 5560 IPT a lot, you may find it more comfortable to use a headset. See the headset usage section on page 22 for more information.

### Protect your hearing

Your 5560 IPT has a control for adjusting the volume of the handset receiver or headset. Because continuous exposure to loud sounds can contribute to hearing loss, keep the volume at a moderate level.

### Adjust the viewing angle

The stand built into your 5560 IPT tilts to give you a better view of the keys. Refer to Figure 2.

To tilt your 5560 IPT for better viewing:

With the front of the 5560 IPT facing away from you, locate the adjustment handles on either side of the terminal stand and push them away from you to loosen.

Tilt the stand to the desired position and then pull the ratchet handles toward you to tighten.

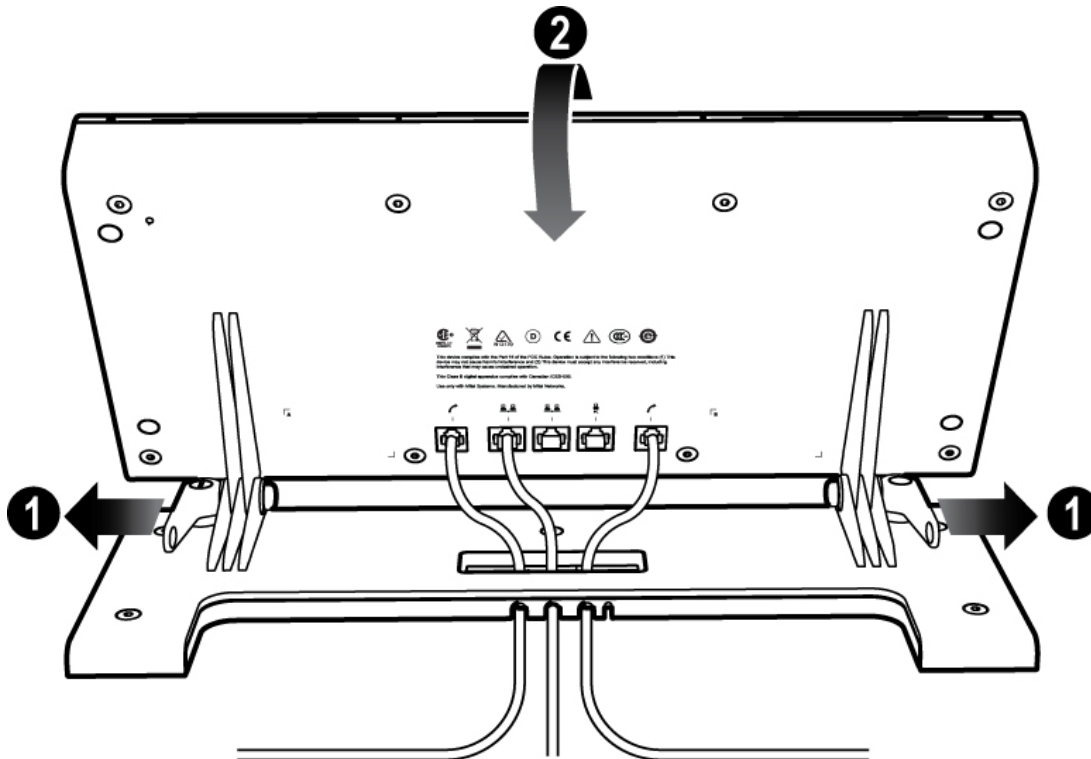

LL0167

Figure 2. Adjusting the viewing angle

## 5560 IPT AUDIO MODES

Your 5560 IPT has two audio modes: single and dual. Audio mode is automatically determined by the number of handsets/headsets attached to the 5560 IPT. The following table explains how your 5560 IPT behaves and how you can use it in each audio mode.

<b>5560 IPT Audio Mode Behavior and Use</b>		
<b>Feature</b>	<b>Single Audio Mode</b>	<b>Dual Audio Mode</b>
<b><i>Audio and Call Support</i></b>		
Audio paths	One	Two – left and right
Active calls	One active call at a time	Two active calls simultaneously
Programming mode	Switch the context to the side you want to program by pressing the Prime Line key on that side.	Program either side – it's not necessary to switch context
<b><i>Handset/Headset</i></b>		
Connectivity	One handset or headset in either left or right port.	Any combination of two handsets or headsets.
Behavior	Single handset/headset can access any line.	Left handset accesses the lines associated with the left side. Right handset accesses the lines associated with the right side.
Use	Use single handset no matter which 'side' the call is associated with.	Use left handset for calls on the Left side. Use right handset for calls on the Right side.
<b><i>Key Use</i></b>		
Left/Right keys	Not required.	Press Left/Right to switch between left and right audio paths, and to control the common keys.
Common keys – keypad, Menu, Speaker, Hold, Microphone, Vol+, Vol-, Trans/Conf, and Cancel	Key presses are delivered to the display that was most recently active.	Press Left if you want subsequent presses of the common keys to apply to the left handset. Press Right to apply common key presses to the right handset.
Line keys/Programmed keys	Press keys on either the Left or Right display, no matter which handset you are using.	Use the Left handset when you press a key on the Left display. Use the Right handset when you press a key on the right display.
Release keys	Press either of the two Release keys to end a call, no matter which handset you are using.	Press the left Release key for a call on the left side. Press the right Release key for a call on the right side.

### **Switching Audio Modes**

**NOTE:** Switch between single and dual audio modes **only** when the 5560 IPT is idle. If you switch during a call, you may lose track of which audio path you initiated or accepted the call on, then consequently lose the connection with the caller.

**NOTE:** Some cordless headsets have a "power saver" option. Activation of this mode may cause the 5560 IPT to revert to single audio mode. Return to dual audio by deactivating the "power saver" mode on the headset.

### Switching between Audio Paths in Dual Audio Mode

- Use the **Left** or **Right** handset (or headset) accordingly.

#### Notes:

- Switching calls does not place an active call on hold. Press the corresponding Left or Right Key and then press **Hold**.
- If the call being switched to is in Handsfree mode, switch to it by pressing **Left** or **Right** (to associate the common keys including **Microphone** to the correct audio path), **Speaker**, then **Microphone**. See *Handsfree Operation* on page 23.

### Tips for Using this Guide

- You can perform all the procedures in this guide on either the left or right side independently. Program each side of the 5560 IPT independently, and dial from each side.
- To avoid confusion, this guide does not specify whether you should use the right or left handset/headset or fixed function key, because that depends on your particular call situation.
- When this guide tells you to press one of the keys—for example, “Press Release”—it means press the key that applies to the left or right handset, as needed in your particular call situation. Similarly, when this guide tells you to access a feature menu—for example, “Press the key you have programmed as People”—it means launch the People application on the left or right display, as needed for your purposes.

## USING YOUR DEFAULT WINDOWS AND KEYS

The default 5560 IPT windows and keys are shown and described below. The default window provides access to Applications and programmable keys. Use the default window to program feature keys.

### Getting Started with 5560 IPT

When you receive your 5560 IPT, you need to program features and applications. Pressing the MENU key provides a list of the applications you can use to customize your 5560 IPT. (See **Figure 3**, right-hand display.)

You can use the People application to access/edit your contact list, or the Call Forwarding application to set up call forwarding profiles. Use the Settings application to program your personal settings like key programming, display brightness, and audio level. For more information about the applications, see *Using Your 5560 IPT Applications* on page 9.

You program the left and right sides of your 5560 IPT separately, which means you may do all programming procedures described in this section on one and then the other side of the 5560 IPT.

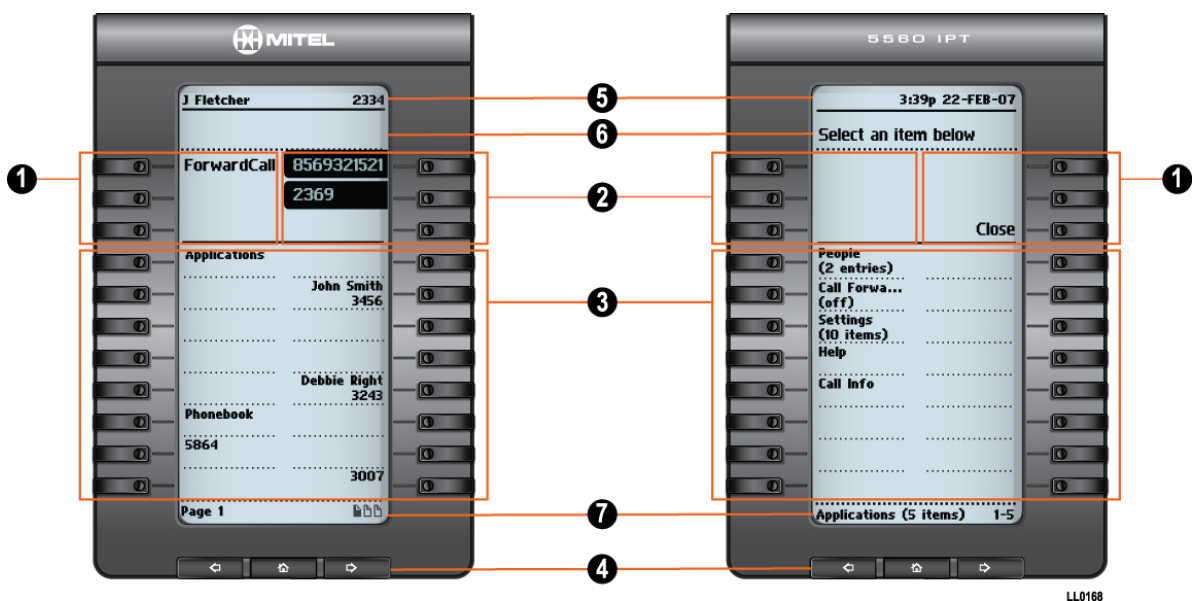



**Figure 3. 5560 IPT Display Windows**

#### 5560 IPT Default Window and Keys (see Figure 3)

Feature	Function
1) Softkeys	Allow you to access the call control features that pertain to the feature you are currently using. These keys are non-programmable and are specific to the application or the state of the terminal. The 5560 IPT provides 6 softkeys, 3 on each side. Softkey prompts appearing in the display correspond to the relevant call, so you may see different contextual softkey prompts on each side at the same time.

### 5560 IPT Default Window and Keys (see Figure 3)

Feature	Function
2) Float Keys	Display the queue of ringing calls. Up to three concurrent incoming calls per side appear on Float keys with associated labels.
3) Programmable Keys	Launch specific call control features. Press the <b>Menu</b> key to access the <i>Settings</i> application to program these keys. The 5560 IPT provides 16 programmable keys per page on each display (a maximum of 94 programmable keys when prime line keys are taken into account). For instructions about programming the keys, see <i>Programming Features on Your Keys</i> on page 15 .
4) Page Navigation Keys	Display additional pages of information. The 5560 IPT has three page navigation keys for each display: Back, Next, and Home.
5) Status Line	Displays time, date, and icons indicating feature states as follows: <ul style="list-style-type: none"> <li>• <b>Message Waiting</b> (  ) - Indicates new voice mail.</li> <li>• <b>DND</b> (  ) - Indicates DND (Do not disturb) mode.</li> <li>• <b>Logged in as</b> (  ) – Indicates that a hot desk user is logged in.</li> <li>• <b>Applications Loading ...</b> - Displays during startup.</li> </ul>
6) Information Area	Provides prompts in most applications. Content changes based on the application/context.
7) Footer	Shows context and summary information based on information in the Programmable Keys area, such as page indicators and quantity of items.

### For Users on Resilient 3300 ICP Systems

If during a call, you hear a beep repeated every 20 seconds it means that your 5560 IPT is switching to a secondary 3300 ICP system. After the call is cleared, the 5560 IPT switches over to the secondary ICP. There may be a change in operation of some keys and features. Normal operation resumes when your 5560 IPT switches back to the primary system. If your 5560 IPT is idle and switched to the secondary system, you'll see a flashing rectangle on the display. The rectangle remains until the switch to the primary system is complete.

If the 5560 IPT fails over to the secondary ICP, you have access to your mailbox on the secondary ICP only if a mailbox has been programmed for you by your Administrator.

**Note:** The mailbox on the secondary ICP will not contain the same messages as the mailboxes on the primary ICP. Any preferences that are voice mail-related are not carried from the primary ICP to the secondary ICP. These preferences must be set on both ICPs.

---

## USING YOUR 5560 IPT APPLICATIONS

---

Your 5560 IPT provides applications that simplify use of your telephony device. Press the **Menu** fixed function key in conjunction with the Left or Right button to open the Applications window and show the current status of all applications.

To open an application, press the key beside the application name:

- **People:** Use the People application to add, delete and edit contact names and numbers. You can also dial anyone on your contact list from the People application. The People window displays up to eight contacts per page, ordered alphabetically by last name. See *Using the People Application* on page 18 for more information.
- **Call Forwarding:** Use the Call Forwarding application to create Call Forward profiles that identify where to send your incoming calls. The Call Forwarding window displays a list of the Call Forwarding profiles you have created and indicates which one is active. See *Call Forward* on page 19 for more information on how to add, edit, delete, and activate Call Forwarding profiles.
- **Settings:** Use the Settings application to display and quickly change your 5560 IPT's current configuration settings and personal key programming. See *Using the Settings Application* on page 9 for more information.
- **Help:** Use the Help application to launch 5560 IPT Quick Help. See *Getting Help* on page 10 for more information.
- **Call Info:** Use the Call Info application to display caller information on your 5560 IPT's prime line. Call Info appears automatically on incoming calls if the Call Notification—Display Call Info Setting is enabled and Call Info is available. For more information, see *Using the Call Info Application* on page 18.

### Using the Settings Application

Use the *Settings* application to access your 5560 IPT's general configuration options and to program personal keys.

To access the *Settings* application:

1. Press the **Left** or **Right** key and then press the **Menu** fixed function key.
2. Press **Settings** to open the Settings window and display the following configurable options:
  - **User Information:** to specify your name and/or extension number (See page 11)
  - **Programmable Keys:** to assign features (like "Speed Call") and applications (like "People") to the programmable keys on your 5560 IPT (See page 16 )
  - **Text Size:** to specify the font size (large or small). (See page 13 )
  - **Call Notification:** to specify when the default Phone window should appear. (See page 13 )
  - **Brightness and Contrast:** to adjust the display brightness and contrast of your 5560 IPT. (See page 12 )
  - **Screen Saver:** to specify a specific time of inactivity on your 5560 IPT that triggers the screen saver to display. (See page 14 )
  - **Audio Feedback:** to enable, disable, and adjust the volume of the audio feedback (error beeps). (See page 12 )

- **External Message:** This application is not supported in Release 1.0.
- **Go to URL:** This application is not supported in Release 1.0.
- **About 5560 IPT:** to display information about the software release.

## Getting Help

To access the 5560 IPT help system:

1. Press the **Left** or **Right** key and then press the **Menu** fixed function key.
2. Press **Help**.
3. Press the < and > keys to view **Quick Help** items or press **Key Icons** to view a legend of 5560 IPT display icons.
4. Press **Close** to exit Help.

---

## CUSTOMIZING YOUR 5560 IPT

---

Use the *Settings* application to customize your 5560 IPT. Customize both Left and Right displays independently, as the settings are not shared.

**Note:** The System Administrator can invoke a Lock to Factory default option on a per-5560 IPT basis. When this is in effect, the following settings are set by the system administrator and you cannot change them:

- Programmable Keys
- External Messaging
- Go to URL

### Specify User Information

To specify the number or name displayed on your 5560 IPT:

1. Press the **Left** or **Right** key and then press the **Menu** fixed function key.
2. Press **Settings**.
3. Press **User Information**.
4. Press **Edit Name**.
5. In the on-screen keyboard, press the appropriate letters to spell your name. (See *Using the Onscreen Keyboard* on this page for more information.)
6. Press **Save**.
7. Press **Edit Number**.
8. In the on-screen keyboard, press the appropriate numbers for your line. (See *Using the Onscreen Keyboard* on this page for more information.)
9. Press **Save**.
10. Press **Save** again.

**Note:** Press **Cancel** at any time to exit this application without making any changes or press **Clear** to clear the entered name and number. Press **Close** to close the window and return to the default window.

**Note:** If both name and number are programmed, only Name appears on the display.

### Using the Onscreen Keyboard

The onscreen keyboard is used to enter name and number information into 5560 IPT applications and features.

To type **Name** information when the onscreen keyboard appears:

- Press the right-hand page navigation key to see uppercase letters. Press the left-hand page navigation key to return to the lowercase selection.
- Repeatedly press the key next to the character you want to enter until that character is highlighted and then press **Insert**. If you make an error, use the **←** control key or **Backspace** to make corrections.
- After you have entered all characters, press **Save**.

To type **Number** information when the onscreen keyboard appears:

Do one of the following:

- Press the key beside the digit you want to enter
- When you have finished selecting digits, press **Save**.

### Specify Display Brightness and Contrast

You can adjust the brightness and display contrast either via the 5560 IPT volume controls (when the terminal is idle) or via the *Settings* application.

To adjust the display contrast using the volume controls:

1. Press **Left** or **Right** to select the display to which you wish the changes to apply.
2. Repeatedly press **Vol +** or **Vol -**.
3. Perform the same steps for the other display, as needed.

**Note:** You can use this method only when the 5560 IPT is idle. If the terminal is ringing, this action adjusts the ring volume. If the terminal is in use, this action adjusts the handset, headset and speakerphone volume.

To adjust the display brightness and contrast using the *Settings* application:

1. Press the **Left** or **Right** key and then press the **Menu** fixed function key.
2. Press **Settings**.
3. Press **Brightness and Contrast**.
4. Press the Brightness and Contrast keys to adjust the brightness and contrast of your screen.
5. Press **Save**.
6. Perform the same steps for the other display, as needed.

**Note:** Press **Cancel** at any time to exit this application without making any changes.

### Specify Audio Feedback Options

The error beep volume in the 5560 IPT is related to the volume of the speaker. You can set the beep volume using this procedure; however, adjusting the speaker volume also affects the beep volume.

To adjust the volume of the audio feedback:

1. Press the **Left** or **Right** key and then press the **Menu** fixed function key.
2. Press **Settings**.
3. Press **Audio Feedback**.

4. Set the options using the appropriate actions described below:

<b>Option</b>	<b>Action</b>
Turn audio feedback off for errors	Press <b>Turn Off</b> .
Adjust audio level for error beeps	Press <b>Volume +</b> or <b>Volume –</b>
Turn audio feedback on for errors	Press <b>Play Error Tone</b>

5. Click **Save**.
6. Perform the same steps for the other display, as needed.

**Note:** Press **Cancel** at any time to exit this application without making any changes.

### Specify Text Size

To specify the text size that displays on the 5560 IPT:

1. Press the **Left** or **Right** key and then press the **Menu** fixed function key.
2. Press **Settings**.
3. Press **Text Size**.
4. Select **Large Text** or **Small Text**.
5. Press **Save**.
6. Perform the same steps for the other display, as needed.

**Note:** In some instances, using Large Text size may result in truncated key labels. To restore proper key labeling, switch to the Small Text setting.

### Specify Call Notification Behavior

To specify that the *default 5560 IPT* window automatically displays when you are making or receiving calls:

1. Press the **Left** or **Right** key and then press the **Menu** fixed function key.
2. Press **Settings**.
3. Press **Call Notification**.
4. Press the appropriate options to identify when you want the default Phone window to display:

<b>Select this option...</b>	<b>To make the Phone window open when...</b>
Made	you begin an outgoing call
To my prime line	you receive an incoming call on your prime line
To my other lines	you receive an incoming call on any line other than your prime line
To any appearance	you receive an incoming call on any line appearance

5. Press **Save**.
6. Perform the same steps for the other display, as needed.

**Notes:**

- When **To my prime line** is selected, select **Display Call Info** to display Call Information instead of the default 5560 IPT window.
- Press **Cancel** at any time to exit this application without making any changes.

### Adjust Ringer

To adjust the Ringer Volume while the 5560 IPT is ringing:

- Press **Vol +** or **Vol -**.

**Note:** If the 5560 IPT is in talk state, this action adjusts the volume of the handset, headset or speaker. If the 5560 IPT is idle, this action adjusts the contrast.

### Enable a Screen Saver

You can program your screen saver to turn on after a specific time period of inactivity on your 5560 IPT. Perform this procedure from both Left and Right sides individually, as settings are not shared.

To enable a screen saver:

1. Press the Left or Right key and then press the **Menu** fixed function key.
2. Press **Settings**.
3. Press **Screen Saver**.
4. Select the inactivity time, which will activate the backlight switch to dim.
5. Press the **Display image** checkbox if you wish the default screen saver image to be displayed when the backlight dims. (If you do not press this checkbox, only backlight dimming occurs.)
6. Select a brightness level for the dimmed backlight by pressing **Brightness +** or **Brightness -**.
7. Press **Show Brightness** to temporarily demonstrate the selected brightness level.
8. Press **Save**.

## PROGRAMING FEATURES ON YOUR KEYS

### Tips for Programming Features

You can assign Features (like "Speed Call"), or Applications (like "People") to the programmable keys on your terminal. Program the keys on left and right sides individually, as key programming is unique to each side. You can edit the default label for each key and personalize them using the instructions on page 17.

Use the Settings application whenever possible to program keys. Use the programmable Superkey only to program features that cannot be programmed through the Settings applications (see *Features that must be set using a programmed Superkey.*)

**Note:** Only the System Administrator can program line select and line appearance keys. By default, the user's Prime line is Key 1 (right-hand lowermost key) for both Left and Right displays.

### Features available for programming on programmable keys:

- Speed Call
- Music
- Night Answer
- Account Code Verified
- Account Code Non-Verified
- Hot Desking
- Phonebook
- Speak@Ease
- Auto Answer
- Paging
- Call Pickup
- Call Back
- Headset
- Make Busy
- Campon
- Override
- Direct Page
- Do Not Disturb
- Single Flash
- Double Flash
- Meet Me Answer
- Message Waiting Indicator
- Emergency Call
- Tag Call
- Privacy Release
- Swap
- Release
- Call History
- Call Park
- Call Park Retrieve
- Group Listen
- Superkey
- Redial
- Speaker
- Message
- Hold
- Transfer/Conference
- Cancel
- Analog Line

### Features that must be set using a programmed Superkey:

- Timed Reminder
- Hot Desk PIN Change
- Advisory Messages
- Music
- Language
- Ringer Volume/Pitch (when the 5560 IPT is idle)

### Applications available for programming on programmable keys

- Applications (list)
- People
- Call Forwarding
- Settings
- Help
- Call Info

### Program Feature Keys Using the Settings Application

To program a 5560 IPT feature key:

1. Press the **Left** or **Right** key and then press the **Menu** fixed function key.
2. Press **Settings**.
3. Press **Programmable Keys**.
4. Press the key you want to program.
5. If Applications are displayed, press the **View Features** softkey. (Conversely, if you want to program an application to this key, and features are displayed, press the **View Applications** softkey.).
6. Use the Page Navigation keys (→ and ←) to move through the features list.
7. Select the desired feature or function from the list. A default label is automatically assigned to the key.
8. For most features, you can press **Save** now and you are finished with this procedure. If you are programming Speed Call, Message Waiting Indicator, Call Park, or Call Park Retrieve, do the following:
  - Press the **Edit Number** field.
  - In the on-screen keyboard, enter the appropriate numbers that correspond to the prompt.
  - Press **Save**.
9. Press **Close** and then press **Close** again to return to the Phone window. The feature key you have programmed appears.

**Note:** If you want to personalize the key label, refer to *Edit Key Labels* on page 17.

To program a 5560 IPT Application:

1. Press the **Left** or **Right** key and then press the **Menu** fixed function key.
2. Press **Settings**.
3. Press **Programmable Keys**.
4. Press the key you wish to program.
5. If Features are displayed, press the **View Applications** softkey.
6. Select the desired application.
7. Press **Save**. The key you selected is labeled with the name of the selected application.
8. Press **Close** and then press **Close** again to return to the Phone window.

**To program Speed Call:**

1. Press the **Left** or **Right** key and then press the **Menu** fixed function key.
2. Press **Settings**.
3. Press **Programmable Keys**.
4. Press the key you wish to program. If you want to reprogram an existing key, select the key and press **Clear Key**.
5. Use the page navigation keys to find the Speed Call option and then press **Speed Call**.
6. Press **Edit Number** to enter number using onscreen keypad **only** and then press **Save**.
  - The maximum length is 26 characters (valid characters are 0-9, # and \*.)
  - The terminal dial pad cannot be used to enter the number.
7. Press **Edit Label** to enter label info using onscreen keypad only, and then press **Save**.  
**Note:** If you do not perform this step, your Speed Call key will have a blank label.
8. Press **Save**, and then press **Save** again.
9. Press **Close**.

**Note:** To return to the Features or Applications list at any time, press **Cancel**.

**Edit Key Labels**

To change the labeling of a programmed feature key:

1. Press the **Left** or **Right** key and then press the **Menu** fixed function key.
2. Press **Settings**
3. Press **Programmable Keys**.
4. Select the key you want to edit.
5. Press **Edit Label**.
6. Press **Backspace** to remove the existing label, if required.
7. Use the onscreen keyboard to enter the new label. Press the page navigation keys for uppercase letters and symbols.
8. When label entry is complete, press **Save**.
9. Press **Close** to exit the Settings application.

**Clear Programming from a Key**

You may want to clear the programming from a key if you are no longer using it.

To clear the feature or application programming from a key:

1. Press the **Left** or **Right** key and then press the **Menu** fixed function key.
2. Press **Settings**.
3. Press **Programmable Keys**.
4. Press the key you wish to clear.
5. Press **Clear Key**.
6. Press **Cancel** or reprogram the key with another feature/application.

## Using the People Application

---

Use the People application to set up your contact list. Customize both left and right contact lists individually, as the lists are unique to each display.

### Setting Up Your Contact List

You can add a name to your contact list by entering it directly using the People application or by copying a number from the Call Info window. Since a contact's phone number is mandatory and its name is optional, you are prompted to enter the number first.

To add a name to your contact list using the People application:

1. Press the **Left** or **Right** key and then press the **Menu** fixed function key.
2. Press **People**.
3. Press **New**.
4. Enter the number.
5. Press **Save**. The First Name window appears.
6. Use the onscreen keyboard to enter the first name of your contact.
7. Press **Save**.
8. To enter a last name for your contact, press **Last Name** and use the onscreen keyboard to enter the last name.
9. Press **Save**.
10. Press **Close**.

### Editing information in your contact list

1. Open the **People** application.
2. Press the name you wish to edit.  
**Note:** If you wish to delete the name from your contact list, press **Delete**.
3. Press **Edit Name**.
4. Use the on-screen keyboard to update the appropriate information.
5. Press **Save**.
6. Press **Edit Number**.
7. Use the on-screen keyboard to update the appropriate information.
8. Press **Save** followed by **Close**.

## Using the Call Info Application

---

Use the Call Info application to view name, number, and time information for incoming calls. You can also copy the information on view to the contact list in your People application.

To copy information from the Call Info window to your contact list:

1. In the Call Info window, with the desired information displayed, click **Copy to Contacts**. The name and number information are copied to your contact list.

---

## Using the Call Forwarding Application

---

The Call Forwarding application lets you set up profiles to redirect incoming calls to an alternate number when your 5560 IPT is busy, when you're not answering, or all the time.

### Program Call Forward Profiles

You can create multiple Call Forwarding profiles that identify where to send your incoming calls. After you create and save a profile in the Call Forwarding application, you can enable or disable it at any time.

Notes:

- Only one call profile can be active at a time.
- The currently active profile is shown with option button selected.
- The default profile appears when the Call Forwarding set-up does not match any of your profiles.
- The None profile is a default profile provided by the system. It has no numbers programmed and is used to turn off Call Forwarding.
- Create Call Forwarding profiles for both Left and Right displays.

To create a Call Forward profile:

1. Press the **Left** or **Right** key and then press the **Menu** fixed function key.
2. Press **Call Forwarding**.
3. Press **New Profile**.
4. Press **Edit Profile Name**.
5. Use the on-screen keyboard to enter the profile name and press **Save**. Select a profile name that indicates the destination to which your calls will be forwarded.
6. Select one of the following Call Forward categories:
  - **Always**: forwards all your calls
  - **Busy Internal**: forwards internal calls after several rings if your line is busy
  - **Busy External**: forwards external calls after several rings if your line is busy
  - **No Answer Int**: forwards internal calls after several rings if you don't answer
  - **No Answer Ext**: forwards external calls after several rings if you don't answer

**Note:** You can select one or more settings but the Always setting takes priority over all other settings.
7. For each of the Call Forward categories:
  - Press **Edit Number** to display the on-screen keyboard.
  - In the on-screen keyboard, enter the appropriate number.
  - Press **Save**.

8. Press **Save**. The edit window closes. This profile is saved but it is not activated. To activate this profile, see *Activate Call Forward*.

**Note:** Press **Cancel** at any time to exit this application without making any changes.

### **Activate Call Forwarding Profile**

To turn on a Call Forwarding profile after it has been programmed:

1. Press the **Left** or **Right** key and then press the **Menu** fixed function key.
2. Press **Call Forwarding**.
3. Press the appropriate Profile setting.
4. Press **Activate**.

### **Cancel Call Forwarding Profile**

To cancel a Call Forwarding profile:

1. Press the **Left** or **Right** key and then press the **Menu** fixed function key.
2. Press **Call Forwarding**.
3. Press **None**.
4. Press **Activate**.

---

## MAKING AND ANSWERING CALLS

---

You can make a call using one of the following methods:

- Dial the number using the keypad.
- Press a key that is programmed as a **Private Line** key.
- Press a key you have programmed as a **Speed Call** key.
- Dial a number from the **People** application
- Use **Phone Book** (see *Phone Book* below).

**TIP:** In dual audio mode, the light on the **Left/Right** keys indicates which handset (or headset) is active.

### Dial from a Private Line Key

To make a call from a Private Line Key:

- Press any key that is programmed as a Private Line. You are automatically connected to the number of the party who is programmed on that key.

**Note:** Only your System Administrator can program Private Lines.

### Dial from a Speed Call Key

- Press a key you have programmed as a Speed Call associated with the party you want to call.

### Dial from the People Application

To dial a contact from your People list:

1. Open the People application by pressing **Menu**, and then **People**.
2. Use the navigation keys to page through the contact list and select the name.
3. Dial the contact using one of the following methods:
  - Select a contact name and press **Dial**.
  - Press the key to the right of the contact's dial icon in the main list. (The contact name does not need to be selected.)

**TIP:** The light on the **Left/Right** keys indicates that that handset is active. If the handset you want to use is active, you do not need to select it.

### Dial from the Keypad

1. Press **Left** or **Right** to select the handset (or headset) you wish to use for the call.
2. Dial the number on the keypad.

## Phone Book

To use Phone Book:

1. Press **Phone Book**.
2. Enter the name of the desired party, as follows:
3. For each letter in the name, press the appropriate key on the terminal dialpad until the letter is shown in the display. For example, if the letter C is required, press the digit 2 three times. Use the **<—** softkey to correct errors.
4. Press the **—>** softkey to enter the next letter.
5. If required, press the **—>** softkey to add a space between the first and last name.
6. Press **Lookup**.
7. If no match exists, edit the original entry.
8. If more than one match is found, press the **Next** softkey to find your selection.
9. Do one of the following:
  - To make the call, press **Call**.
  - To edit the entry, press **Backup**.
  - To exit, press **Release** or **Cancel**.

**TIP:** In dual audio mode, the light on the Left/Right key indicates which handset is active. If the handset you want to use is already active, you do not need to select it.

## Answer a call

1. Select the line key or float key for the ringing line that is flashing.
2. Do one of the following:
  - Use the handset/headset associated with the display that received the call
  - Use the speaker/microphone

### To answer using speaker/microphone:

1. Select the ringing line or Float key line.
2. Press **Speaker**, and then do one of the following:
  - Press and immediately release **Microphone** to turn the microphone on continuously
  - Press and hold **Microphone** to use the push-to-talk microphone feature

**Note:** The microphone is muted by default. The push-to-talk microphone feature allows you to answer and make calls in intercom fashion, that is, by holding down the microphone button when you wish to speak, and releasing it when you are finished speaking.

## End a call

Do one of the following:

- To end a call and free the line, press the **Release** button on the side that received the call.
- To end a call and maintain the dial tone press **Cancel**.

## Switch between two active calls (Dual Audio Mode)

- Press **Left** or **Right** accordingly.

Notes:

- Switching calls does not place an active call on hold. Press the **Hold** key to hold.
- If the call being switched to is in Handsfree mode, switch to it by pressing **Left** or **Right** (to associate the common keys including **Microphone** to the correct call), **Speaker**, then **Microphone**. See *Handsfree Operation* on page 23.

## Redial

To redial the last number that you manually dialed:

- Press the key you have programmed as **Redial**.

## Redial - Saved Number

To save the last number that you manually dialed:

1. Press **Left** or **Right** to select the handset/headset you wish to use.
2. Dial the appropriate feature access code.

To redial a saved number:

1. Press **Left** or **Right** to select the handset/headset you wish to use .
2. Dial the appropriate feature access code.

## Handsfree Operation

The **Speaker** fixed function key turns Handsfree on and off. You can have one active call on the speaker at one time. If the 5560 IPT is in dual audio mode, you can also have an active handset or headset call on the other audio path simultaneously.

To use Handsfree to make a call:

1. Press your Prime Line key or any Line Appearance key. **Note:** Your administrator must program Line Appearances.
2. Dial the number.
3. Press **Speaker**.
4. To speak when the called party answers, do one of the following:
  - Press and immediately release **Microphone** to turn the microphone on continuously
  - Press and hold **Microphone** to use the push-to-talk Microphone feature.
5. To switch between two active calls, see *Switch between two active calls* on page 23.

To use Handsfree operation to answer calls:

1. Press the flashing line key or Float key.
2. Press **Speaker**.
3. Do one of the following:
  - Press and immediately release **Microphone** to turn the microphone on continuously
  - Press and hold **Microphone** to use the push-to-talk Microphone feature
4. Begin speaking.
5. If the other audio path is or becomes active, press **Speaker**, press **Left/Right** to select the **other** audio path, then switch to the other handset or headset for that call. Press **Speaker** again to return to the Handsfree speaker call.

**Note:** Pressing **Speaker** retrieves the Handsfree call to the handset. If you press **Speaker** before answering the other call, you ensure that your Handsfree caller does not hear the other conversation. If you are using the microphone in push-to-talk mode, you may not need to press **Speaker** because your Handsfree speaker call is automatically muted when you release the **Microphone** key.

To hang up while using Handsfree operation:

- Press **Release**.

To retrieve a call to a handset (or headset):

- Press the active line key.
- Press **Speaker**, then press **Left** or **Right** to select the **same** audio path associated with the display that initiated or accepted the call.

To return to Handsfree operation:

- Press **Speaker**, then press **Left** or **Right** to return the call on that audio path to Speaker.

### Auto-Answer

When the Auto-Answer feature is active, incoming calls ring briefly, and then the 5560 IPT answers the call in Handsfree mode. You can continue the call handsfree or use the handset.

To enable or disable Auto-Answer:

- Press the key you have programmed as **Auto-Answer**. The key is highlighted and all incoming calls are answered in Handsfree mode.

To switch from Handsfree mode to handset (or headset) mode:

- Press **Speaker**, then press **Left** or **Right** to select the **same** audio path associated with the display that initiated or accepted the call.

To end a call, do one of the following:

- Press **Release** on the appropriate side of the 5560 IPT.
- Press **Cancel**.
- Wait for the caller to hang up.

---

## CALL HANDLING

---

### Hold

To place a call on Hold:

- Press **Left** or **Right** to select the **same** audio path associated with the display that initiated or accepted the call.
- Press **Hold**.

**Note:** You can only retrieve a call from hold when the 5560 IPT is idle.

To retrieve a call from Hold, do one of the following:

- Press the flashing line key or Float key.
- Press **Add Held** to conference into the held call.

To retrieve a call from Hold at another 5560 IPT, do one of the following:

- Press the flashing line key.
- Press **Left** or **Right** to select the handset/headset you wish to use, then dial the appropriate feature access code and the number of the station that placed the call on Hold.

### Transfer

To Transfer an active call:

1. Press **Left** or **Right** to select the handset/headset you wish to use.
2. Press **Trans/Conf**.
3. Dial the number of the third party.
4. Do one of the following:
  - To complete the transfer, press **Release**.
  - To announce the transfer, wait for an answer, consult, and then press **Release**.
  - To cancel the transfer, press **Cancel**.

To transfer an active call during headset operation:

1. Press **Left** or **Right** to select the handset/headset you wish to use.
2. Press **Trans/Conf**.
3. Dial the number of the third party.
4. To complete the transfer, press **Release**.

### Conference

To form a Conference when a two-party call is already in place, or to add another party to an existing Conference:

1. Press **Left** or **Right** to select the handset/headset you wish to use.
2. Press **Trans/Conf**.
3. Dial the number of the next party.
4. Wait for an answer.

5. Press **Trans/Conf**.

To leave a Conference:

- Do one of the following:
  - Press **Release Me**.
  - Press **Release**.
  - Press **Cancel**.

### Conference Split

To Split a Conference and speak privately with the original party:

- Press the **Split** softkey.

### Add Held

To move a call on hold to another line appearance:

1. Press any available line appearance key.
2. Press **AddHeld**.
3. Press the flashing line key.

To add a call on Hold to an existing conversation or conference:

1. Press **AddHeld**.
2. Press the flashing line key.

### Swap

To call another party when you are in an established two-party call:

1. Press **Left** or **Right** to select the handset/headset you wish to use.
2. Press **Trans/Conf**.
3. Dial the number.

To alternate between the two parties:

- Press **Trade Calls**.

---

## USING OTHER FEATURES

---

How you use features on your 5560 IPT depends on whether your 5560 IPT is in single or dual audio mode. In single audio mode, perform any of the following procedures on either Left or Right display and use either handset (or headset). In dual audio mode, perform any of the following procedures on each display independently, then use the handset (or headset) associated with that audio path. See *About 5560 IPT Audio Modes* on page 4 to understand how to handle calls and use features with single and dual audio modes.

### Account Codes

An account code is a series of digits that you assign to your calls, usually for accounting purposes. The code identifies the account in the call records that your system generates. A forced account code is usually entered from another extension, enabling you to use features or make calls that the extension otherwise could not. If you want this feature enabled on your 5560 IPT, ask your System Administrator.

To use Forced Account Codes:

1. Press **Left** or **Right** to select the handset/headset you wish to use.
2. Dial the Account Code digits.
3. Press #.

To enter an Account Code during a call:

1. Press the key you have programmed as **Verified Account Code** or **Non-verified Account Code**.
2. Dial the Account Code digits.
3. Press **Save**.

### Attendant Call Hold - Remote Retrieve

To retrieve a call placed on Hold by the attendant:

1. Press **Left** or **Right** to select the handset or headset you wish to use.
2. Dial the appropriate feature access code.
3. Dial the digits announced by the attendant.

### Callback

The Callback feature allows you to be notified when a busy station becomes free or when a station has been used after a no-answer condition was encountered.

To request a Callback when you reach a busy or unanswered station:

1. Press **Call Me Back**.
2. Press the **Release** that corresponds to the side of the 5560 IPT you are using.

When the party is available, your 5560 IPT starts ringing, and the display shows the Callback ringing indicator with the calling party's phone number.

To answer a Callback:

- When the Callback notification appears (a Float key with calling party's name label), press the Float key to call the calling party OR press the flashing line key.

## Call History

Call History keeps track of the names (if available) and telephone numbers of missed calls, answered incoming external calls, and outgoing external calls. When enabled on your 5560 IPT by your system administrator, it functions automatically.

To display the call history, and view call detail:

1. Press the key you have programmed as **Call History**. The total number of Missed Calls is displayed in brackets (), the number of new missed calls is indicated with a \*.
2. To browse through the list of missed calls, press the **Yes** softkey, followed by the **Vol +** or **Vol -** keys to scroll through the list.
3. To view Answered Calls or Outgoing calls, press the **No** softkey (once for Answered, twice for Outgoing), followed by the **Vol +** or **Vol -** keys to scroll through the list.
4. To view the number of the call, press the **Details** softkey.

To return a call:

1. Display the call you want to return.
2. Do one of the following:
  - If the call is internal, and the caller name is known, press the Call softkey. For unknown numbers, the Call option is not displayed.
  - If the call is external, and you normally need to precede external calls with a digit such as 9, it is likely that your system administrator has programmed your system to insert the 9 for you. In this case, pressing the Call softkey initiates the call immediately. Sometimes the system will be unable to complete the dialing automatically. When this happens, you can edit the dialed digits manually by pressing the <— (Clear) softkey. Use the <— (Clear) softkey to delete the left-most digit, and then type the digits to insert them. When you have the dial string edited to suit your needs, press the Call softkey to dial the number.

### To delete all missed, answered, or outgoing call logs:

1. After selecting the type of logs you wish to delete, press the **Delete All** softkey.
2. Confirm that you do want to delete all items by pressing the **Yes** softkey.

To delete a particular call from the call log:

- With the call log that you want to delete displayed, press **Yes** twice or press the **Delete** softkey.

## Call Park

The Call Park feature allows you to place a call in a special hold state. You, or someone else, can then retrieve the call from any extension in the system.

After parking the call, the system can automatically connect you to paging equipment so that you can announce the call to the requested party.

To park an active call:

1. Do one of the following:
  - Press the key you have programmed as **Call Park**.
  - Press **Left** or **Right** to select the handset/headset you wish to use, press **Trans/Conf**, and then dial the appropriate feature access code. The display shows PARKED@, followed by

the park destination and parking spot index (if applicable). Example: PARKED@ 1234 @ 02.

2. Dial the directory number on which to park the call (not required if the number is programmed to the **Call Park** feature key).
3. To inform a user that a parked call is waiting, do one of the following:
  - If automatic paging is enabled, announce the call and the park retrieve digits shown on the display.
  - If automatic paging is disabled, press the key you have programmed as **Page**, or dial the appropriate feature access code, followed by the Paging zone number (if required). Then, announce the call and the park retrieve digits shown on the display.

**Note:** Paging over a loudspeaker is not permitted in handsfree mode; you must use the handset or headset.

To retrieve a parked call:

1. Do one of the following:
  - Press **Left** or **Right** to select the handset/headset you wish to use, then dial the appropriate feature access code.
  - Press the key you have programmed as **Call Park - Retrieve** feature key
2. Dial the directory number on which the call is parked (not required if the number is programmed to the **Call Park** feature key).
3. If there are multiple calls parked on the number, dial the two-digit index number to retrieve a specific call, or # to retrieve the longest parked call.

## Call Pickup

To answer a call that is ringing at another extension in your Pickup Group:

1. Press **Left** or **Right** to select the handset or headset you wish to use.
2. Press the key that you have programmed as **Pickup**.

To answer a call that is ringing at another extension not in your Pickup Group:

1. Press **Left** or **Right** to select the handset or headset you wish to use.
2. Dial the appropriate feature access code.
3. Dial the number of the ringing station.

## Campon

When you get a busy tone, you can use the Campon feature to be notified when the busy party becomes available.

To Campon to a busy station:

- Press **I Will Wait**.

To retrieve a call when you hear the Campon tone:

- Use the **Trade Call** or **Call Swap** feature with the **Trans/Conf** hardkey or a programmable line key.

## Direct Paging

Direct Paging allows you to page a party through the party's handsfree speaker. If the paged party has Off-Hook Voice Announce enabled, the page will be heard even when the party is on a handset or headset call.

To page a party:

1. Press **Left** or **Right** to select the handset or headset you wish to use.
2. Press the key you have programmed as **Direct Paging** or dial the appropriate feature access code.
3. Dial the extension number.
4. Speak to the dialed party after the tone.

## Do Not Disturb

When you enable Do Not Disturb, callers will get a busy tone, and an on-screen text message indicating that you do not wish to be disturbed.

To activate or deactivate Do Not Disturb:

- Press the key you have programmed as **Do Not Disturb**. The key is illuminated when Do Not Disturb is activated and is not illuminated when Do Not Disturb is not activated. The 5560 IPT status line displays the Do Not Disturb  icon.

To activate Do Not Disturb from a remote extension:

1. Press **Left** or **Right** to select the handset or headset you wish to use.
2. Dial the appropriate feature access code.
3. Dial the number of the station to which Do Not Disturb is to apply.
4. Press **Release**.

To deactivate Do Not Disturb from a remote station:

1. Press **Left** or **Right** to select the handset or headset you wish to use.
2. Dial the appropriate feature access code.
3. Dial the number of the station with Do Not Disturb activated.
4. Press **Release**.

## Emergency Calls

**Warning for emergency number dialing:** Consult your local authorities for Emergency Numbers and 911 or equivalent service availability in your area.

### EMERGENCY CALLS WHEN EMERGENCY CALL ROUTING PROGRAMMED

**Note:** This procedure is applicable only when the 5560 IPT has been properly registered with the 3300 ICP.

To make an Emergency Call if Emergency Call Routing is programmed:

1. Press **Left** or **Right** to select the handset or headset you wish to use.
2. Dial your Local Emergency Number (911 or equivalent).

## Group Listen

With Group Listen, you can carry on a conversation using the handset or headset while allowing others nearby to listen to the person at the far end over the handsfree speaker. The handsfree microphone is disabled in Group Listen mode.

To activate Group Listen while in a handset conversation:

- Press the key you have programmed as **Group Listen**. Audio from the far-end party is now heard through both the handset/headset and the speaker.

To make the call a normal two-way speaker call:

- Press **Speaker**, then either press and immediately release **Microphone** to turn the microphone on continuously; **or** press and hold **Microphone** to use the push-to-talk Microphone feature.

To exit Group Listen mode (and return to a normal handset/headset call):

- Press **Group Listen**.

To activate or deactivate Group Listen while in headset mode:

- Press **Group Listen**.

## Group Paging / Meet Me Answer

Group Paging allows you to page a group of telephony devices through their built-in speakers. You can belong to as many as three paging groups with one group designated as your "prime" group.

When you need to respond to a Group Page but you don't know the identity or extension number of the paging party, use the Meet Me Answer feature. You have up to 15 minutes after receiving the page to use Meet Me Answer.

To make a Group Page:

1. Do one of the following:
  - Press the key you have programmed as **Direct Page**.
  - Dial the appropriate feature access code.
2. Do one of the following:
  - To page your prime page group, press **#**.
  - To page a specific page group, dial the page group directory number.
3. Speak to the dialed party after the tone.

To respond to a Group Page by using Meet Me Answer:

1. Do one of the following:
  - Press the key you have programmed as **Meet Me Answer**.
  - Press **Left** or **Right** to select the handset or headset you wish to use and then dial the appropriate feature access code.
2. Do one of the following:

- To respond to a page from your prime page group, press **#**.
- To respond to a page from a specific page group, dial the page group directory number.

## Headset Operation

Connect your headset to the appropriate (left or right) handset/headset jack on the back of the 5560 IPT. For headset operation in Single and Dual audio mode, see Audio Mode Behavior on page 5.

**Note:** Not all headsets are compatible with the 5560 IPT.

To answer a call (when Auto Answer is disabled):

- Press the flashing line key or Float key.

To hang up:

- Press **Release**.

## Hot Desking

Hot Desking allows you to log into the telephone system from any 5560 IPT designated as a Hot Desk device. When you log in at the 5560 IPT using your assigned Hot Desk User Extension Number, the device assumes your speed dials, feature keys, call forwarding setup, and line appearances. Any changes you make to the 5560 IPT while you are logged in--for example, adding a speed dial--are saved to your personal profile. Logging in activates your profile on any 5560 IPT that supports Hot Desking.

When you log in as a Hot Desk user, Call History data is updated for you. You do not see any call logs for the telephony device's registered DN; you only see your own history data. When you log out, the history data of the registered DN is displayed. To access your voice mail when you are logged in as a hot desk user, you must log in to your voice mail.

To log into a Hot Desking 5560 IPT (the 5560 IPT must be idle):

1. Press the **HotDesk** softkey.
2. Press **Login**.
3. Using the dial pad, enter your Hot Desk User Extension Number and then press **OK**.
4. Enter your PIN number and press **OK**. A message displays indicating that applications are being loaded. The 5560 IPT status line shows the Hot Desk  icon while you are logged in.

To log out of Hot Desking 5560 IPT (the 5560 IPT must be idle):

1. Press **HotDesk**.
2. Press **Logout**. Your Hotdesk information appears.
3. Press **Logout** again to confirm.

**Note:** Your profile can only be active on one side of one 5560 IPT at a time. If you log in from another 5560 IPT without logging out from the first one, the system will automatically deactivate your profile on the first terminal.

## Hot Desk Remote Logout

A user who has forgotten to log out of a Hot Desking 5560 IPT can be logged out from a device that is configured to allow Hot Desk Remote Logout.

**Note:** This feature must be enabled by your System Administrator via Class of Service option.

To remotely log out a Hot Desking 5560 IPT:

1. Press **Left** or **Right**, and then dial the appropriate feature access code.
2. Dial the Hot Desk User Extension Number that you want to log out.
3. Press **Logout**.
4. Press **Confirm**.

## Hot Desk - PIN Change

To change your Hot Desk PIN:

1. Log into a Hot Desking 5560 IPT.
2. Press the key that you programmed as **Superkey**.
3. Press **No** until "HOT DESK PIN?" appears.
4. Press **HotDesk PIN**.
5. Enter the current PIN or skip to step 6 if a PIN has not yet been assigned.
6. Press the **Enter** softkey.
7. Enter the new PIN. The PIN can include digits from 0 to 9 only and can be 0 to 8 characters in length.
8. Press **Enter**.
9. Re-enter the new PIN.
10. Press **Superkey** to exit.

## Message

You can program a Message key that indicates when you have a message waiting and automatically connects you to your voice mail for retrieval. For key programming instructions, see *Program Feature Keys* on page 16.

To use the Message key:

- Press the key you have programmed as **Message** and follow the voice mail prompts to retrieve your messages.

## Message Waiting Indicator

The Message Waiting Indicator (MWI) feature key allows you to be notified when messages have been left for another device. When programming the MWI feature key, you are prompted to enter the number of the device to monitor. For key programming instructions, see *Program Feature Keys* on page 16.

To use the MWI key:

- Press the programmed **MWI** key and follow the voice mail prompts to retrieve messages left for the programmed extension.

## Messaging - Advisory

Advisory Messaging enables you to select a notice that appears on your 5560 IPT display to inform people visiting your desk of your whereabouts. Select from a variety of advisory messages, including "On vacation", "In a meeting", or "Out to Lunch".

To turn Advisory Messaging on:

1. Press the key you have programmed as **Superkey**.
2. Press **No** until "ADV MESSAGE" appears and then press **Adv Msg**.
3. Press **Next** until the desired message appears.
4. Press **Turn Msg On**. This message appears in your callers' phone displays.

To turn Advisory Messaging off:

1. Press the key you have programmed as **Superkey**.
2. Press **No** until "ADV MESSAGE" appears and then press **Adv Msg**. The terminal displays the current advisory message.
3. Press **Turn Msg Off**.

## Message - Callback

To leave a Callback Message when you hear busy or ringback tone:

- Press the key that you programmed as **Message** or press the **Callback** softkey.

To respond to a message waiting condition on your 5560 IPT:

1. Press the key that you programmed as **Message**.
2. Press **Read Msg**. The calling number, time, and date of the call are displayed.
3. Do one of the following:
  - Press **More Msg...** to see the next message. (**Start of Msg** indicates a return to the beginning of the list.)
  - Press **Call** to call the message source
  - Press **Erase** to delete the message

## Messaging - Cancel Callback

To cancel a Callback:

1. Press **Left** or **Right** to select the handset or headset you wish to use.
2. Dial the appropriate feature access code.
3. Dial the number of the called station.
4. Press **Release**.

## Messaging - Cancel All Callbacks

To cancel all Callbacks:

1. Press **Left** or **Right** to select the handset or headset you wish to use.
2. Dial the appropriate feature access code.
3. Press **Release**.

## Music

To turn Music on and off when the 5560 IPT is idle, do one of the following:

- To turn music on, press the key that you have programmed as **Music**.
- To turn music off, press the key that you have programmed as **Music**.

When Music is activated, Music key is highlighted.

## Night Answer

The Night Answer feature allows you to route calls to an attendant or message at night.

To enable Night Answer:

- Press the key you have programmed as **Night Answer**. When you have enabled Night Answer, this key is highlighted.

To disable Night Answer:

- Press the key you have programmed as **Night Answer**.

## Override (Intrude)

When you dial a number whose owner has enabled the Make Busy feature, your 5560 IPT displays a message indicating that the called line is busy. You have the option to override this setting.

To use Override when you encounter a busy tone:

1. Press the key you have programmed as **Override**.
2. Wait for an answer.

## Paging

To use Paging:

1. Press the key that you have programmed as **Direct Page**.
2. Dial the Paging zone number (if required).
3. Make the announcement.

## Reminder

To program a Reminder:

1. Press the key you have programmed as **Superkey**.
2. Press **No** until "TIMED REMINDER?" appears.
3. Press **Reminder**.
4. Enter the time in 24-hour format.
5. Press **Save**.

To view, change, and/or cancel a pending Reminder:

1. Press the key you have programmed as **Superkey**.
2. Press **No** until "TIMED REMINDER?" appears.

3. Press **Reminder**.
4. Do one of the following:
  - Press **Change** to change the reminder time, enter the new time, and then press **Save**.
  - Press **Cancel No.** to cancel the reminder.
  - Press **Superkey** to exit without making changes.

To acknowledge a Reminder when your 5560 IPT rings once:

- Press **Confirm**.

## Ringer Adjust

Adjusting ringer volume and pitch while the 5560 IPT is idle requires you to program a Superkey feature key.

To adjust the Ringer Volume while the 5560 IPT is idle:

1. Press **Left** or **Right** to select the display to which you wish the changes to apply.
2. Press the key you have programmed as **Superkey**.
3. Press the **No** softkey until "Ringer Adjust?" appears.
4. Press **Ring Adjust**.
5. Press **No**.
6. Press **Ringer Vol**.
7. Press **Vol +** or **Vol -**.
8. Press **Superkey**.
9. Perform the same steps for the other display, as needed.

To adjust the Ringer Pitch while the 5560 IPT is idle:

1. Press **Left** or **Right** to select the display to which you wish the changes to apply.
2. Press the key you have programmed as **Superkey**.
3. Press the **No** softkey until "Ringer Adjust?" appears.
4. Press **Ring Adjust**.
5. Press **Ringer Pitch**.
6. Press **Vol +** or **Vol -**.
7. Press SuperKey.
8. Perform the same steps for the other display, as needed.

## Speak@Ease

The Mitel Speak@Ease feature enables access to the Mitel Speech Server, a speech recognition application that routes incoming calls based on spoken commands.

To dial a call using Speak@Ease:

1. Press the key you have programmed as **Speak@Ease**.
2. Speak the name of the person you wish to call.

## Speed Call

Speed Call is an application that allows you to program and dial specific phone numbers with one key press. For more information about programming Speed Call keys, see *Program Feature Keys Using the Settings Application* on page 16.

To make a Speed Call:

- Press the key that you have programmed as a **Speed Call** key for the number you want to call.

## Tag Call

Tag Call allows you to signal that you are the victim of a threatening or malicious call. Using the tag, your System Administrator or telephone company can identify the source of the call and provide this information to appropriate personnel or authorities.

**CAUTION:** Tagging a non-malicious call may result in fines or other penalties.

To tag a malicious call:

1. Do one of the following:
  - Press the programmed Tag Call key while the call is in progress. For information on how to program keys, see *Programming Features On Your Keys*

-OR-

- Press **Left** or **Right** to select the 'side' that the call came in on, then press **Trans/Conf**.
2. Dial the appropriate feature access code.

If the call was successfully tagged, *Thank You* is shown on the corresponding display; otherwise, *Not Allowed* is displayed.

**Note:** Tag Call can be used on active two-party calls only. Calls on hold and conference calls cannot be tagged.

## Trunk Flash

The Trunk Flash feature allows you to access Centrex features (if available) while you are talking on an outside call.

To flash a trunk while talking on an outside call:

1. Press the key you have programmed as **Single Flash** or **Double Flash**.
2. Wait for dial tone.
3. Dial the Centrex feature access code.